

Tools Required:

3mm hex key



Dimensions

- A: 7-1/2 "
- B: 7-1/4 "



Protection Class: IP 65

Weight: 9.0 lbs

Notice to Installer for 99 776:

1. See page 2 for specific product safety warnings.
2. Fixture may be damaged if connected to conduit systems that contain water - Article 300-5G of the National Electric Code requires that "Conduits or raceways through which moisture may contact energized live parts shall be sealed or plugged at either or both ends."
3. Wet location listing does not imply suitability for exposure to standing water for long periods of time.
4. LEDs are high-quality electronic components! Please avoid touching the light output opening of the LED directly during installation.
5. Supply wiring connection are made to 5-pin connector in accompanying bollard tube. Refer to bollard tube installation instructions for wiring instructions. (Bollard tube with integrated emergency battery pack uses quick disconnects rather than 5-pin connector).

NOTE: For proper installation, an accompanying bollard tube must be selected with the bollard head.

99 776 installation:

1. Install bollard tube per bollard tube installation instructions.
2. Connect male 5-pin connector from bollard head to female 5-pin connector from bollard tube. Twist ring between connectors clockwise as far as it will go until completely sealed. **NOTE: THE CONNECTORS WILL ONLY FASTEN IN ONE ORIENTATION TO ENSURE WIRING CONNECTIONS ARE CORRECT.**
3. Insert bollard head into bollard tube and turn clockwise as far as it will go (Figure 1).
4. Secure bollard head by tightening 6mm hex set screw.

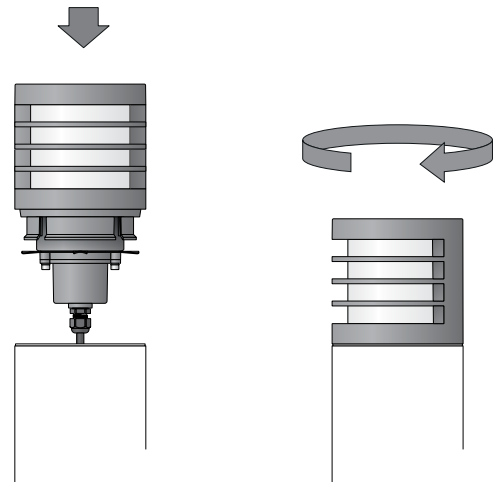

Figure 1

Relamping/Maintenance

No relamping required.

Bollard Tube Options

Please refer to bollard head specification sheet for a complete list of compatible bollard tube options.

Replacement Parts

Description	Part No
Lens	11313911
Lens gasket (top)	830379
Lens gasket (bottom)	831539
Driver (120V-277V)	75983-02
LED Module (3000K)	LED-0382/830
LED Module (4000K)	LED-0382/840

Lamp: 16.5W LED

In the interest of product improvement, BEGA reserves the right to make technical changes without notice.

Product Safety Warnings:

THIS PRODUCT MUST BE INSTALLED IN ACCORDANCE WITH THE APPLICABLE INSTALLATION CODE BY A PERSON FAMILIAR WITH THE CONSTRUCTION AND OPERATION OF THE PRODUCT AND THE HAZARDS INVOLVED. SUITABLE FOR WET LOCATIONS.

MIN 90°C SUPPLY CONDUCTORS.

CE PRODUIT DOIT ÊTRE INSTALLÉ SELON LE CODE D'INSTALLATION PERTINENT, PAR UNE PERSONNE QUI CONNAÎT BIEN LE PRODUIT ET SON FONCTIONNEMENT AINSI QUE LES RISQUES INHÉRENTS. CONVIENT AUX EMPLACEMENTS MOUILLÉS.

LES FILS D'ALIMENTATION 90°C MIN.