

NOTES:

1. SYSTEM BOLLARD UNLIT CAP # 71 127 – SEE SPECIFICATIONS

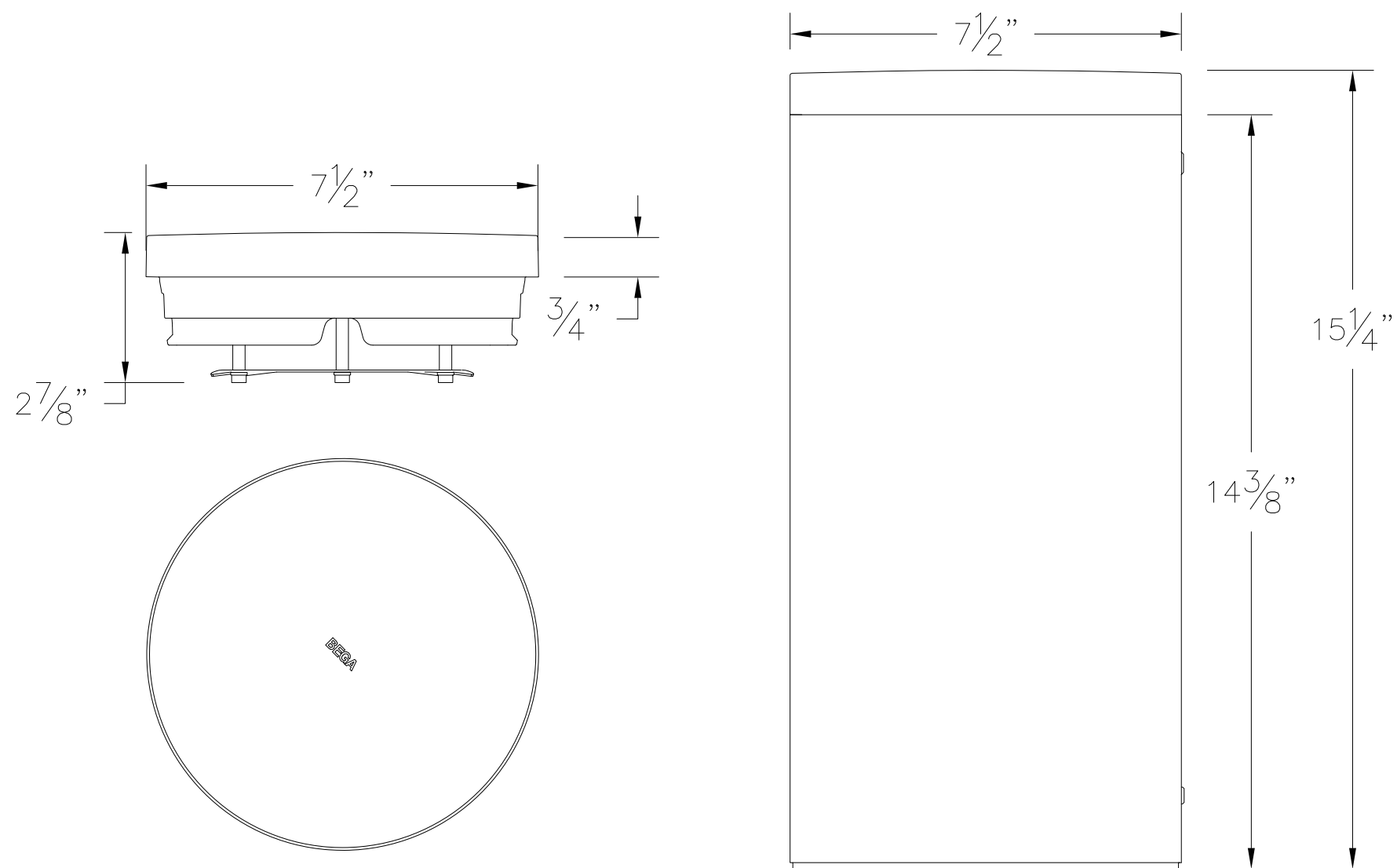

71 127
SHOWN ON
BOLLARD TUBE 99 615

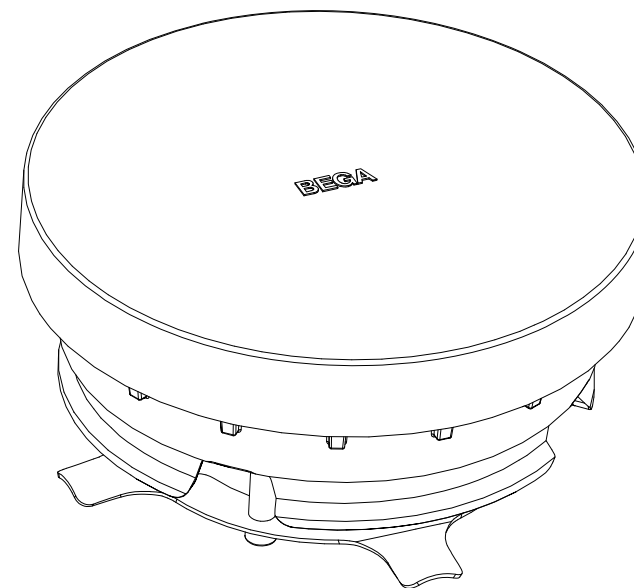

TYPE: _____

SUBMITTAL APPROVAL

APPROVED BY: _____ DATE: _____

SIGNED: _____

REV.	DATE	DESCRIPTION

CAT NO.: LUMINARE# 71127

PROJECT: -

LOCATION: -

DRAWN: MP DATE: 4/1/2019 FILE NAME: 71127.DXF

BEGA

1000 Bega Way
Carpinteria, Ca. 93013
(805) 684-0533

This print contains confidential information which is the property of BEGA U.S. By acceptance this information, the borrower agrees that it will not be used for any other purpose other than that which is was loaned.