

Rough-in kit 19515

for use with Recessed Ceiling Luminaires:

L3869.X, L3552.X, L3289.X, L2224.X

Tools Required:

Phillips medium screwdriver

NOTE: For maximum ceiling thickness- see individual fixture drawings.

Notice to Installer for 19515:

1. See page 2 for specific product safety warnings.
2. Luminaire suitable for new ceiling stud construction or suspended ceilings (T-bar type). Luminaire not suitable for poured concrete construction.
3. Fasteners to attach to T-bar system (Caddy Fasteners #ATS41) included.
4. Minimum ceiling clearance is 4-3/4".
5. Ceiling cut out is 2-11/16".
6. Integral LED module and mounted LED Driver included.
7. IC box must be accessible from above during wiring installation.

19515 Rough-in kit installation:

1. For ceiling stud construction: Position rough-in kit in ceiling so bottom of box will sit on top of ceiling material. Adjust bar hanger wires if needed. Nail conduit brackets to available ceiling structure.
For suspended ceiling construction: Conduit brackets can be directly attached to (4) Caddy Fasteners #ATS41 for attachment to T-bar. Attach brackets to fasteners, and then attach to T-bar. Level rough-in kit so bottom of box will sit on top of ceiling material.
2. Pull off ceiling box cover.
3. Bring supply wiring in to IC box and make connections from supply wires to driver connector:
MAIN VOLTAGE SUPPLY WIRE TO BLACK DRIVER TERMINAL
NEUTRAL (COMMON) SUPPLY WIRE TO WHITE DRIVER TERMINAL
GREEN GROUND WIRE TO GREEN DRIVER TERMINAL

Dimming (if applicable):

- DIMMING CONTROL WIRE (+) TO POSITIVE DRIVER DIM CONTROL WIRE
 - DIMMING CONTROL WIRE (-) TO NEGATIVE DRIVER DIM CONTROL WIRE
4. Replace IC box cover and tighten using (4) wing-nuts (provided).
 5. Finish ceiling. Ceiling cut out is 2-11/16".

Fixture Installation:

NOTE: See individual fixture installation instructions for specific product safety warnings and notices.

1. Carefully unscrew glass diffuser
2. Ensure fixture is attached to IC box via quick disconnect.
3. Place luminaire housing up into ceiling and tighten (2) 2.5mm hex-head screws to engage clamping system to attach and secure luminaire housing ceiling.
4. Ensure trim ring is positioned correctly. Replace glass diffuser. Do not over-tighten.

Maintenance:

1. Carefully unscrew glass diffuser.
2. Unscrew (2) 2.5mm hex-head screws to loosen clamping system.
3. Tilt luminaire and remove through ceiling cutout. Disconnect from driver via quick-disconnect.
4. To access driver, loosen thumb screw to release bracket and driver. Pull bracket and driver out through ceiling cutout.

Figure 1

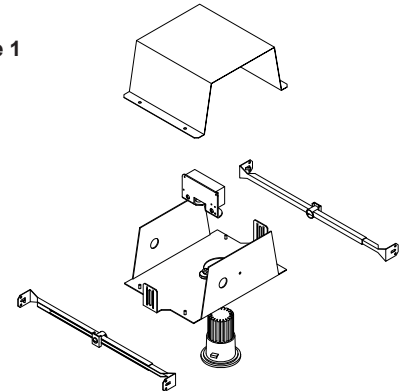

Figure 2: Top View

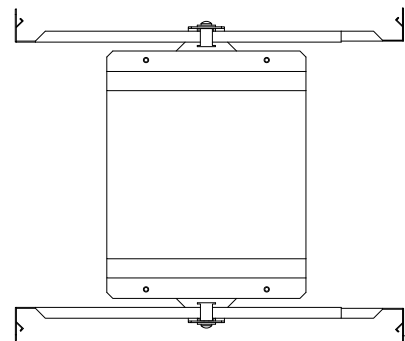
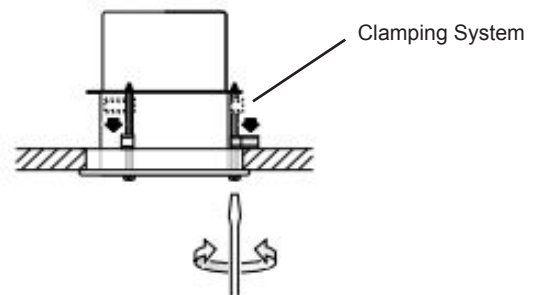

Figure 3 (Generic Image)



In the interest of product improvement, BEGA reserves the right to make technical changes without notice.